

1/25/2017

PARTS LIST  
www.wallacecranes.com

---

MODEL NUMBER 5-10M-8

ITEM NO.	PART DESCRIPTION	PART NUMBER	QUAN.
1	I-BEAM	749-0080	1
2	I-BEAM BRACKET <sup>1</sup>	6051-0400	8
3	SPACE BAR	1744-0010	2
4	TROLLEY STOP ANGLE	6054-0000	4
5	TROLLEY STOP BOLT	51-0095	4
6	TROLLEY STOP NUT	54-0080	4
7	TROLLEY STOP LOCKWASHER	58-0080	4
8	SAFETY KEY RING & TAG ASS'Y	82-0030-1969	26
9	UPPER MAIN LEG 2"	6055-0100	4
10	LOWER MAIN LEG 1-3/4"	6056-0100	4
11	BRACE LEG 2"	6053-0100	4
12	CASTER FRAME 2"	6052-0100	2
13	MAIN LEG SUPPORT PIN 1/2" X 4" LG	6060-0001	4
14	BRACE LEG SUPPORT PIN 1/2" X 4-3/16 LG	6060-0002	4
15	LOAD PIN 1/2" DIA.	6061-0000	8
16	BRACE LEG PIN 1/2" X 3-1/2" LG	6060-0003	4
17	CASTER FRAME PIN 1/2" X 3-1/4" LG	6060-0004	4
18	SWIVEL CASTER	N/A	
19	CASTER BOLT 3/8"-16NC X 1-1/2"	N/A	
20	CASTER NUT 3/8"-16NC	N/A	
21	CASTER LOCKWASHER 3/8"	N/A	
22	I-BEAM STABILIZER	1459-MM04	2
23	I-BEAM STABILIZER NUT 3/8"-16NC	54-0060	4
24	I-BEAM STABILIZER BOLT 3/8"-16NC X 1"	51-0190	4
25	I-BEAM STABILIZER CLIP	3286-0000	4
26	I-BEAM STABILIZER LOCKWASHER 3/8"	58-0060	4

<sup>1</sup> = INCLUDES A SET SCREW (63-0100) & HEX NUT (54-0100)

Wallace Products Corp.  
Mighty-Mite  
Parts Location Diagram

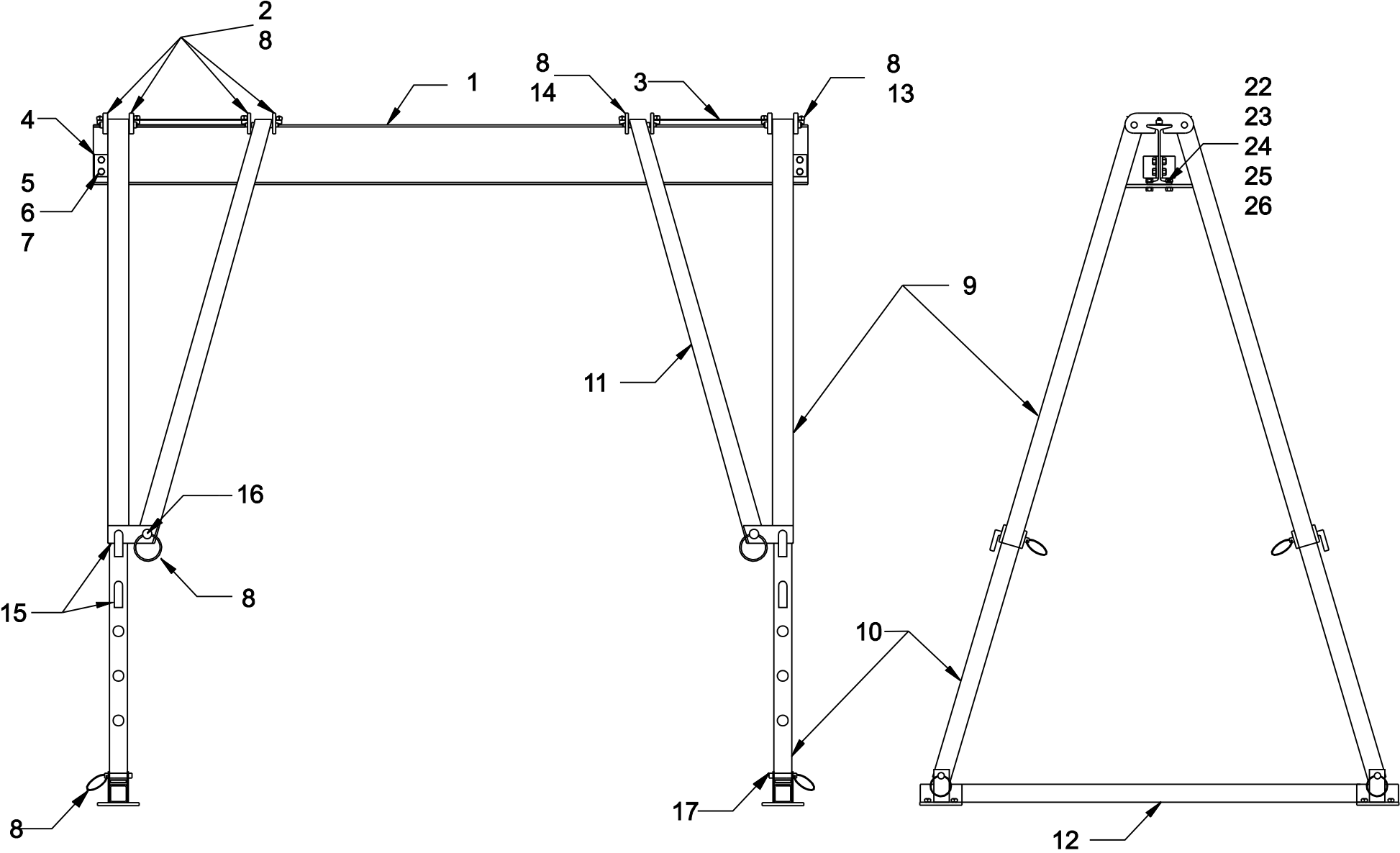

# Wallace Cranes Mighty Mite I-Beam Stabilizer Parts Location Diagram

