

MODEL NUMBER FHS611-S15AC

ITEM NO.	PART DESCRIPTION	PART NUMBER	QUAN.
1	PIN - SUPPORT 1 DIA. X 5 3/4 LG.	5018-0002	4
2	BRACKET - MAIN LEG	6010-1	4
3	HEX. NUT 3/8-24NF	54-0100	8
4	SOC. SET SCREW 3/8-24NF X 1 3/4 LG.	63-0110	8
5	PIN - SUPPORT 11/16 DIA. X 5 11/16 LG.	5017-0006	4
6	SPACER BAR 16" LG.	3604-0006	2
7	BRACKET - BRACE LEG	6010-2	4
8	I-BEAM STL 10" X 15' LG.	762-0150	1
9	KEY RING 2 1/4 DIA.	82-0030	18
10	CAUTION TAG No. 399	1969-RING	16
11	LOCK WASHER INT. TOOTH 3/4	58-0040	4
12	HEX. NUT 3/4-10NC	54-0040	4
13	TROLLEY STOP ANGLE	5132-0000	4
14	HEX. HD. BOLT 3/4-10NC X 2 1/2 LG.	51-0480	4
15	BRACE LEG	3625-0100	4
16	MAIN LEG	3627-0100	4
17	PIN - SUPPORT 11/16 DIA. X 4 9/16 LG.	5017-0004	4
20	HEX. HD. BOLT 1/2-13NC X 4 LG.	51-0460	4
21	LOCK WASHER INT. TOOTH 1/2	58-0020	4
22	HEX. NUT 1/2-13NC	54-0050	4
23	PIN - LOWER LEG 3/4 DIA. X 5 1/8 LG.	5023-0000	4
24	CASTER PLATE H.D.	5047-0000	4
25	HEX. HD. BOLT 1/2-13NC X 1 3/4 LG.	51-0300	16
26	LOCK WASHER INT. TOOTH 1/2	58-0020	16
27	HEX. NUT 1/2-13NC	54-0050	16
28	CASTER WHEEL 8" DIA.	47-81NB	4
29	CASTER FRAME TUBE	3628-0100	2
30	COTTER PIN 1/4 X 2 LG.	60-0040	4

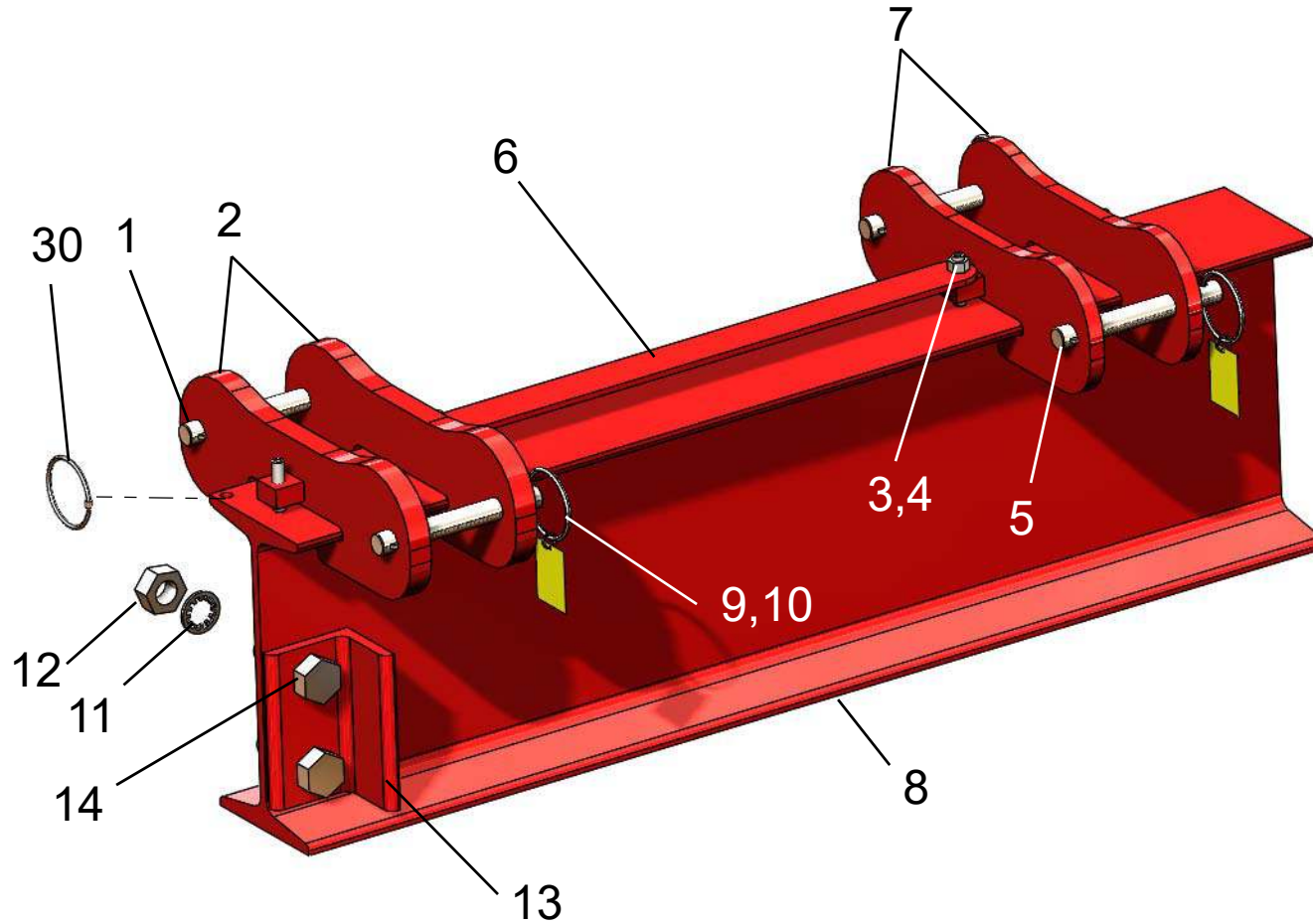

Wallace Cranes Parts Location

Hippolift 1, 2 and 3 Ton



I-Beam
Assembly
Parts Location

Wallace Cranes
71 N Bacton Hill Rd.
Malvern, PA 19355



www.wallacecranes.com
800-553-5438
©2017 All rights reserved



Caster Frame Assembly Parts Location

Wallace Cranes
71 N Bacton Hill Rd.
Malvern, PA 19355



www.wallacecranes.com
800-553-5438
©2017 All rights reserved